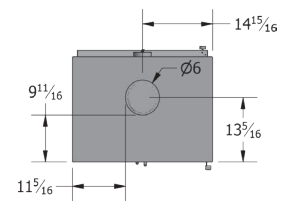
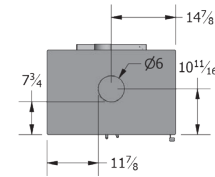
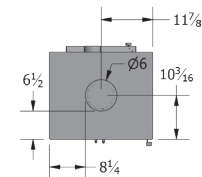
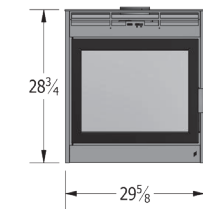
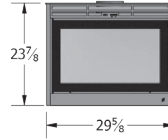
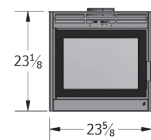
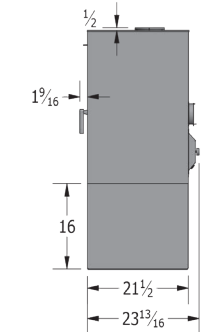
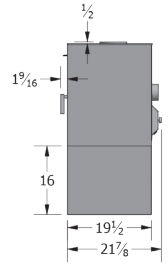
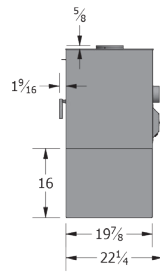
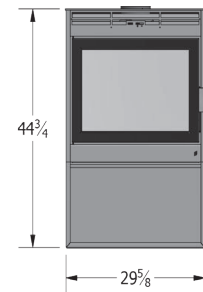
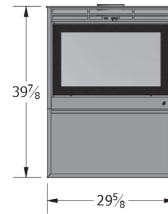
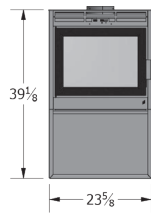
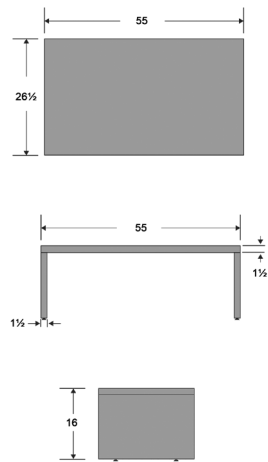
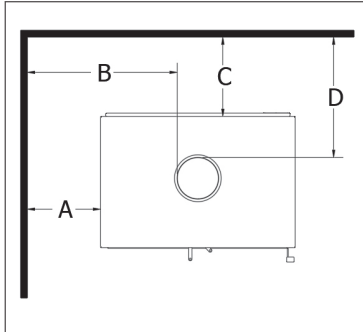

TABLE UNIVERSELLE

| | | | | | |
|--|-----------------------|--|--|--|---------|
| | SUPERFICIE CHAUFFÉE | 500 to 1,000 pi ² | 500 to 1,500 pi ² | 1,000 to 2,500 pi ² | |
| | TEMPS DE CHAUFFAGE | Jusqu'à 10 heures | Jusqu'à 10 heures | Jusqu'à 12 heures | |
| | CHAMBRE À COMBUSTION | 1.8 pieds cubes | 2.4 pieds cubes | 3.8 pieds cubes | |
| | DIMENSIONS DU VERRE | 17 1/8" x 12" | 23" x 12 3/4" | 22 3/4" x 15 3/8" | |
| | PUISSANCE CALORIFIQUE | 60,000 BTUs | 75,000 BTUs | 125,000 BTUs | |
| | LONGUEUR DES BÛCHES | maximum: 18" conseillé: 18" | maximum: 24" conseillé: 18" | maximum: 23" conseillé: 18" | |
| | ÉMISSIONS | 1.99 g/h EPA 2020 certifié | 1.77 g/h EPA 2020 certifié | 1.85 g/h EPA 2020 certifié | |
| | CHEMINÉE | 6 pouces ; approuvée selon les normes UL 103 et ULC S629 | 6 pouces ; approuvée selon les normes UL 103 et ULC S629 | 6 pouces ; approuvée selon les normes UL 103 et ULC S629 | |
| | POIDS | FOYER | 230 lbs | 250 lbs | 300 lbs |
| | | PODIUM | 50 lbs | 55 lbs | 60 lbs |
| | | TABLE | 120 lbs | 120 lbs | 120 lbs |

Dégagements aux Combustibles

La série de poêles Novo a été testée et certifiée selon les normes de sécurité ULC S627 (Canada), UL 1482 (USA) et UL 737 (USA). Les dégagements ci-dessous doivent être respectés pour assurer un fonctionnement sécuritaire de l'appareil, sous des conditions d'usage normal et extrême.

AVERTISSEMENT : Le non-respect des dégagements minimums ci-dessous compromettra la sécurité de l'installation et pourrait causer des dommages à la propriété.



Installation standard

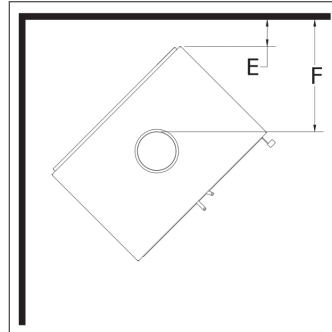

Installation en Coin

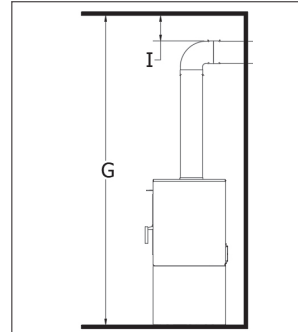

Installation murale

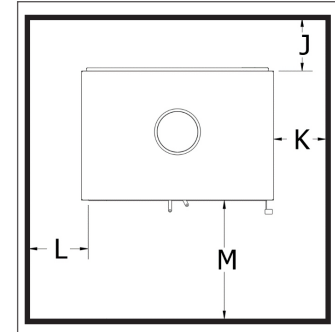

Protection de Plancher

| Connecteur Paroi Simple | Canada | | | USA | | |
|----------------------------|---------|---------|---------|---------|---------|---------|
| | Novo 18 | Novo 24 | Novo 38 | Novo 18 | Novo 24 | Novo 38 |
| A | 18" | 14 7/8" | 14 7/8" | 18" | 14 7/8" | 14 7/8" |
| B | 26 1/2" | 26 1/2" | 26 1/2" | 26 1/2" | 26 1/2" | 26 1/2" |
| C | 11 1/2" | 11 7/8" | 12 1/2" | 11 1/2" | 11 7/8" | 12 1/2" |
| D | 18" | 18" | 18" | 18" | 18" | 18" |
| E | 6 1/8" | 4 1/4" | 4 1/2" | 6 1/8" | 4 1/4" | 4 1/2" |
| F | 18" | 18" | 18" | 18" | 18" | 18" |
| G | 84" | 84" | 84" | 84" | 84" | 84" |
| I | 18" | 18" | 18" | 18" | 18" | 18" |
| J | 8" | 8" | 8" | 0" | 0" | 0" |
| K | 8" | 8" | 8" | N/A | N/A | N/A |
| L | N/A | N/A | N/A | 8" | 8" | 8" |
| M | 18" | 18" | 18" | 16" | 16" | 16" |

Combustibles – Installation sans podium

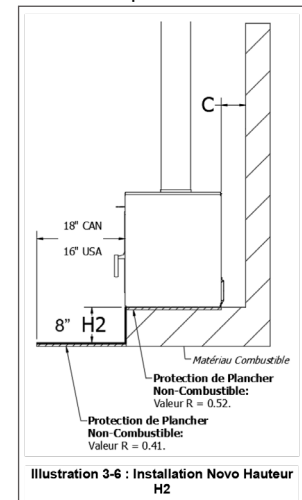
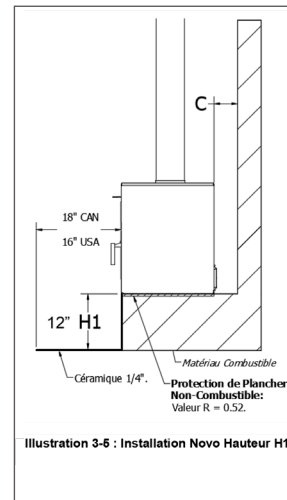

| Connecteur Paroi Double | Canada | | | USA | | |
|----------------------------|---------|---------|---------|---------|---------|---------|
| | Novo 18 | Novo 24 | Novo 38 | Novo 18 | Novo 24 | Novo 38 |
| A | 14" | 11" | 11" | 14" | 11" | 11" |
| B | 22 1/2" | 22 1/2" | 22 1/2" | 22 1/2" | 22 1/2" | 22 1/2" |
| C | 6" | 6" | 6" | 6" | 6" | 6" |
| D | 12 5/8" | 12 1/8" | 11 1/2" | 12 5/8" | 12 1/8" | 11 1/2" |
| E | 3" | 1 1/4" | 1 1/2" | 3" | 1 1/4" | 1 1/2" |
| F | 14 7/8" | 14 7/8" | 14 7/8" | 14 7/8" | 14 7/8" | 14 7/8" |
| G | 84" | 84" | 84" | 84" | 84" | 84" |
| I | 7" | 7" | 7" | 7" | 7" | 7" |
| J | 8" | 8" | 8" | N/A | N/A | N/A |
| K | 8" | 8" | 8" | 8" | 8" | 8" |
| L | N/A | N/A | N/A | 8" | 8" | 8" |
| M | 18" | 18" | 18" | 16" | 16" | 16" |

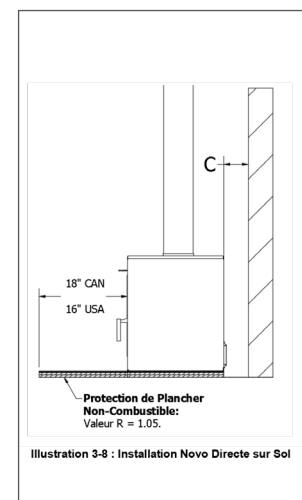
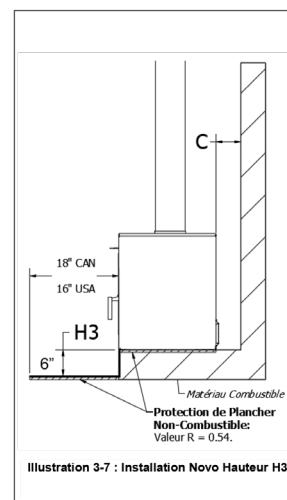

3594 Jarry est, Montréal, Québec H1Z 2G4
 Téléphone: 514 593.4722 Sans-frais: 1 877 593.4722
 www.supremem.com | info@supremem.com

Les informations et les images contenues dans ce catalogue sont sujettes à modification et doivent être utilisées à titre de référence uniquement. Toutes les installations doivent être effectuées conformément aux spécifications détaillées dans le manuel du propriétaire.